

NINJA[®]

PAINTBALL

MADE IN USA 

NINJA PRO V3 SLP REGULATOR OWNER'S MANUAL

SLP - SUPER LOW PRESSURE PRESET AT 300 (+/- 50 PSI)

For more information and PRO V3 product videos visit: www.NinjaPaintball.com



Visit our YouTube Channel for informational product videos

<https://www.youtube.com/user/ninja186>

⚠ WARNING: This is not a toy. Misuse may cause serious injury or death. Eye protection designed specifically for paintball must be worn by the user and persons within range. Recommend 18 years or older to purchase. Persons under 18 must have adult supervision. READ OWNERS MANUAL BEFORE USING.

REFER TO THE NINJA PRO V3 REGULATOR PART DIAGRAM

FILLING THE NINJA PRO V3 REGULATOR SYSTEM

The NINJA PRO V3 Regulator system is equipped with the industry standard “QD Style” fill fitting #12, which allows your Ninja PRO V3 Regulator system to be refilled either on or off the marker. The Ninja PRO V3 Regulator system may be filled with clean, dry Compressed Air or Nitrogen.

 **WARNING: Under no circumstances should the regulator system be filled with pure oxygen. Oxygen will ignite causing injury or death.**

When filling your regulator system do not exceed the pressure rating shown on the cylinder's label.

 **WARNING: Do not apply or inject oil of any type into the fill or burst disk ports. Oil will vaporize and possibly ignite during the fill procedure causing injury or death.**

It is important to keep dirt, oil, and water out of your Ninja PRO V3 Regulator system. Most regulator failures are due to dirt or contamination. Always keep a cover on the fill nipple when you are not filling the Ninja PRO V3 Regulator system. If you use compressed air, make sure that the compressor providing that air is equipped with working filters and moisture separators.

CONNECTING YOUR NINJA PRO V3 REGULATOR

 **WARNING: Prior to every use if your Ninja PRO V3 air system please do the following.**

1. Failure to follow these instructions can result in serious injury.
2. Inspect to make sure the bonnet screws #2 (3) and rotational sleeve #19 set screws, LOCATED BELOW THE PRO V3 LOGO, X (3) are present and securely tightened.
3. Do not use the Ninja PRO V3 Air system if any of the bonnet or rotational sleeve set screws #2 are missing or not securely tightened.
4. Never remove the set screws #2 or adjust the rotational sleeve #19 with pressure in the bottle.

ROTATIONAL ADJUSTMENT

Do not adjust with air in your tank: Tank must be empty.

NOTE: The PRO V3 was shipped with a 5/64 Allen wrench key.

After connecting the Ninja PRO V3 Regulator system into your markers ASA fitting you may wish to orientate your NINJA PRO V3 Regulator. The Ninja PRO V3 Regulator has full 360-degree rotation.

FOLLOW THESE SIMPLE STEPS:

 **WARNING: Before proceeding, make sure your system has been completely degassed via the output pin valve #6, to ensure that no trapped compressed gas is present.**

 **WARNING: Do not adjust with air in your tank. Tank must be empty.**

1. Using the 5/64 allen wrench loosen (turn counterclockwise) the (3) TOP Rotational collar set screws #2. DO NOT REMOVE THE SET SCREWS.
2. Grasp the bottle and turn the NINJA PRO V3 Regulator to your desired location.
3. Tighten the (3) TOP rotational collar set screws #2 securely.
4. Fill your air system.

THE SAFETY SYSTEM

The NINJA PRO V3 Regulator is equipped with an ASTM COMPLIANT bottle Burst Disk #11 required by the Department of Transportation (D.O.T).

In addition to the required safety burst disk #11, the regulator has a Low Pressure (LP) safety burst disk #14 (stamped 1.8K).

The LP (1.8K) safety burst disk #14 is there to protect you and your marker in the unlikely event your Ninja PRO V3 regulator fails.

 **WARNING: Before proceeding, make sure your system has been completely degassed via the output pin valve #6, to ensure that no trapped compressed gas is present.**

 **WARNING: Remember, most regulator failures are the result of contaminated air.**

If the LP (1.8K) safety burst disk #14 vents, it did so for a reason. We recommend you do the following:

Disassemble the regulator (refer to Service and Rebuild procedures), inspect the regulator for contamination and clean if necessary.

Install a new NINJA LP (1.8K) Burst disk #14, PER THE INSTRUCTIONS ON PAGE 6.

If the LP (1.8K) burst disk #14 vents after rebuild see and air smith for help or call us at: 1(815) 477-0007.

NINJA PRO V3 REGULATORS have a Safety Vent Groove on the stem (As shown in below image). This lifesaving feature allows for the venting of the bottle, in the event the regulator is unscrewed from the bottle with pressure present in the bottle.

⚠ WARNING: ALWAYS CHECK TO MAKE SURE THERE IS NO GAP BETWEEN THE BOTTLE AND REGULATOR SEAL. SEE ILLUSTRATION BELOW.

⚠ WARNING: IF THERE IS A GAP STOP!! DO NOT FILL OR USE YOUR SYSTEM.

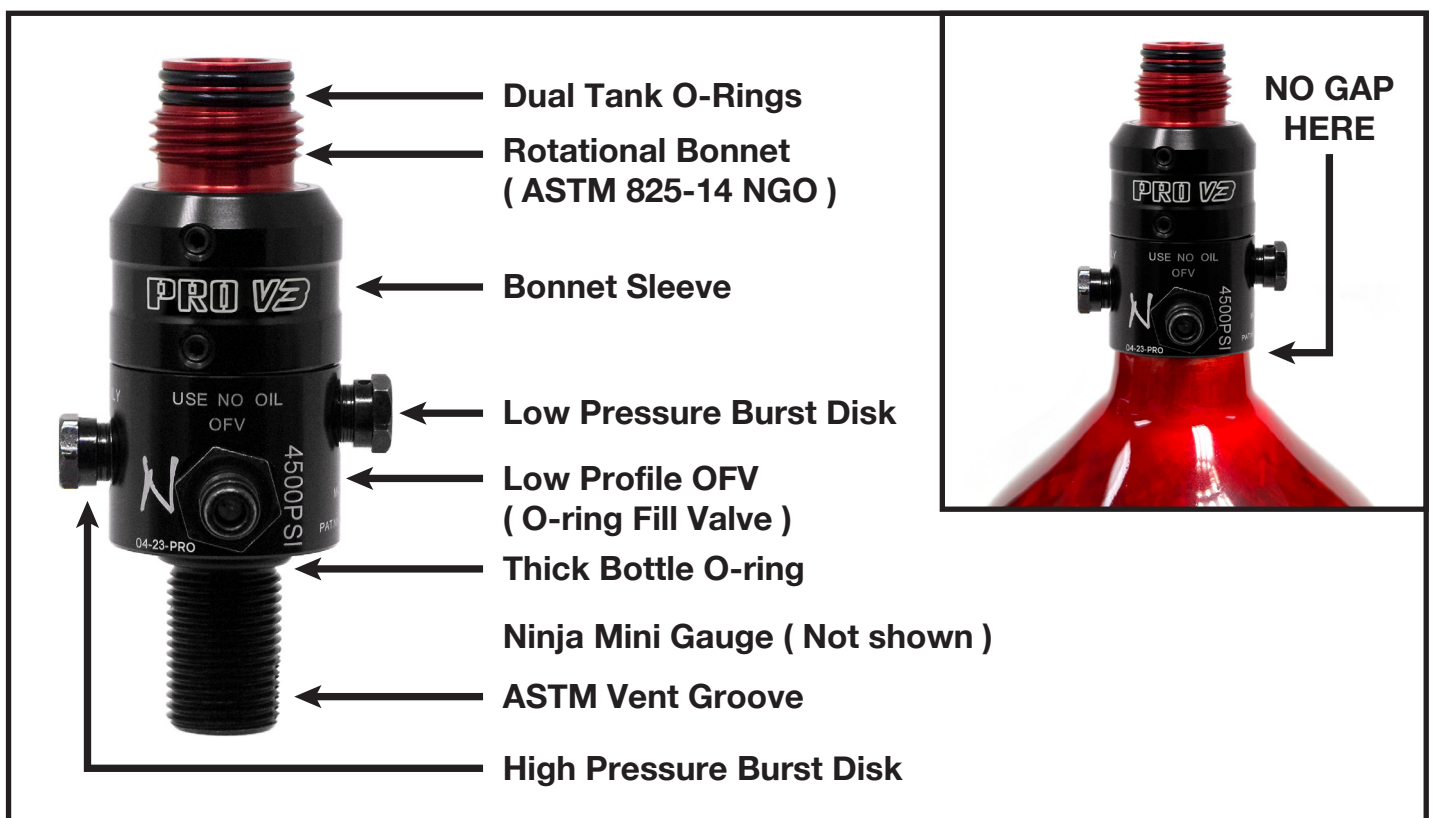

Safely drain your system and wait for the system to fully degas. Contact a qualified Air smith immediately or call us at: 1(815) 477-0007.

PRESSURE INCREASE ADJUSTMENT
SLP REGULATORS ARE NOT ADJUSTABLE.

SERVICE AND REBUILD PROCEDURES
 For safety and reliability only use Ninja replacement parts.

For reference purposes, consult the Ninja PRO V3 regulator part diagram.

⚠ WARNING: Always wear eye protection, gloves and point the air system in a safe direction away from yourself and all bystanders prior to degasing or adjusting the system!

Spare parts and rebuild kits available at your Ninja dealer or visit Ninjaball.com.

NOTE: The following tools are required and are in the parts kit:

- 5/64" Hex key wrench to remove bonnet sleeve #19 set screws.

⚠ WARNING: Prior to disassembly fully degas the air system. Point the bottle away from yourself and bystanders. Depress the pin valve #6 until no air remains in the bottle!

If you are not comfortable with disassembling the regulator, bring the regulator to a qualified air smith or call us at: 1(815) 477-0007.

1. All internal are accessed by unscrewing Bonnet sleeve #19 from the Regulator Body #18 by removing the 3-bonnet sleeve set screws #2 below the PRO V3 logo.
2. After separating the bonnet sleeve #19 from the Regulator Body #18, the shims #8, piston assembly #17, pin Valve #6 & pin spring #7 components can be removed. Helpful Hint: Do not use tools to remove the Piston #17 as this may damage the piston. Firmly grip the end of the piston #17 and wiggle the piston while pulling with your fingers.
3. Clean the inside of the NINJA PRO V3 Regulator body #18 bonnet #3 and piston #17 with a cotton swab and rubbing alcohol.
4. To reassemble, lightly lubricate the Piston O-rings #5 & #10 using a silicone lube.
5. Re-install the Output Pin Valve #6 & Spring #7 by dropping the Pin #6 into the bonnet #3 and make sure the Pin #6 is seated and located in the bonnet #3 pocket.
6. Place the Pin spring #7 into the piston #17 cavity. Carefully push the Piston assembly #17 into the piston bore in the bonnet #3. The Piston #17 must be properly seated in Bonnet #3 before proceeding further. Piston #17 is properly seated when it cannot be pushed in any further.
7. Reassemble. Do not apply excessive torque when screwing the Bonnet sleeve #19 and regulator body #18 together. Replace and securely tighten the (3) Bonnet sleeve set screws #2 with the 5/64" hex key wrench.

PIN VALVE SEAT REPLACEMENT - FOLLOW SERVICE AND REBUILD PROCEDURES FOR BONNET SLEEVE REMOVAL TO ACCESS THE PIN VALVE SEAT AREA

1. The Pin Valve Seat #4 sits inside of the bonnet #3 in the bonnet pocket. To replace the Pin Valve Seat #4 use a small pick to gently pull the Pin Valve Seat #4 from the bonnet #3 taking care to not damage the bonnet #3.
2. When replacing the Pin Valve Seat #4 into the bonnet #3 place the Pin Valve Seat #4 within the inner bonnet #3 pocket and gently push into place using the easer end of a pencil or similar small blunt ended object.

“NEW” NINJAOFV O-RING FILL CHECK VALVE

- Innovative Design
- No need for thread tape or sealant
- Easy positive stop installation

 **WARNING: The NINJAOFV O-ring fill valve #12 will only work with a compatible NINJAOFV series regulator. OFV is lasered above the fill port on the regulator body. See photo below. Do not use the NinjaOFV O-ring fill valve #12 with older Ninja regulator versions or any NON OFV regulator.**

The NINJAOFV O-RING FILL VALVE # 12 on your NINJA OFV SERIES regulator is one of the items that will require periodic replacement, either due to leakage or mechanical damage to the QD portion of the fill nipple which will cause difficulties attaching the OFV fill valve to a fill station.

NINJAOFV O-RING FILL VALVE REPLACEMENT PROCEDURE

1. **ALWAYS WEAR SAFETY GLASSES AND POINT THE REGULATOR AWAY FROM YOURSELF AND ALL BYSTANDERS.**
2. **MAKE SURE THE SYSTEM IS COMPLETELY DE-PRESSURIZED BY DEPRESSING PIN VALVE #6 UNTIL ALL AIR HAS BEEN RELEASED.**
3. Using a 1/2” wrench, turn counterclockwise. Remove the NINJAOFV #12.
4. Clean any debris out of the port.

5. Inspect the 3/8-24 female fill check port threads on the gas distribution body for damage. **IF THREADS ARE DAMAGED OR WORN STOP! DO NOT USE THE REGULATOR SEE AN AIRSMITH OR CALL US AT: 1(815) 477-0007.** It is recommended that a 3/8-24 Class 2B go/no go gauge be used to verify these threads. This gauge is available at www.mscdirect.com

6. **DO NOT USE THREAD TAPE OR SEALANT ON THE THREADS!! THE NINJAOFV #12 WILL SEAL ON THE 011-70B O-RING, NOT THE THREADS.**

7. Make sure the OFV rivet #15 is inserted FULLY into the NINJAOFV #12 as shown below.

8. Install the NINJAOFV #12 assembly turning clockwise until the OFV #12 is hand tight, O-RING IS SEATED IN OFV PORT.

9. Use a 1/2" torque wrench and torque to 55-85 INCH POUNDS. Fill the bottle to verify no leaks.

10. **If the fill valve is leaking STOP and contact an Air smith or call NINJA PAINTBALL for assistance: (815) 477-0007.**

⚠ WARNING: Never inject oil into the fill port valve. Oil droplets can vaporize and ignite during the fill procedure causing injury or death.

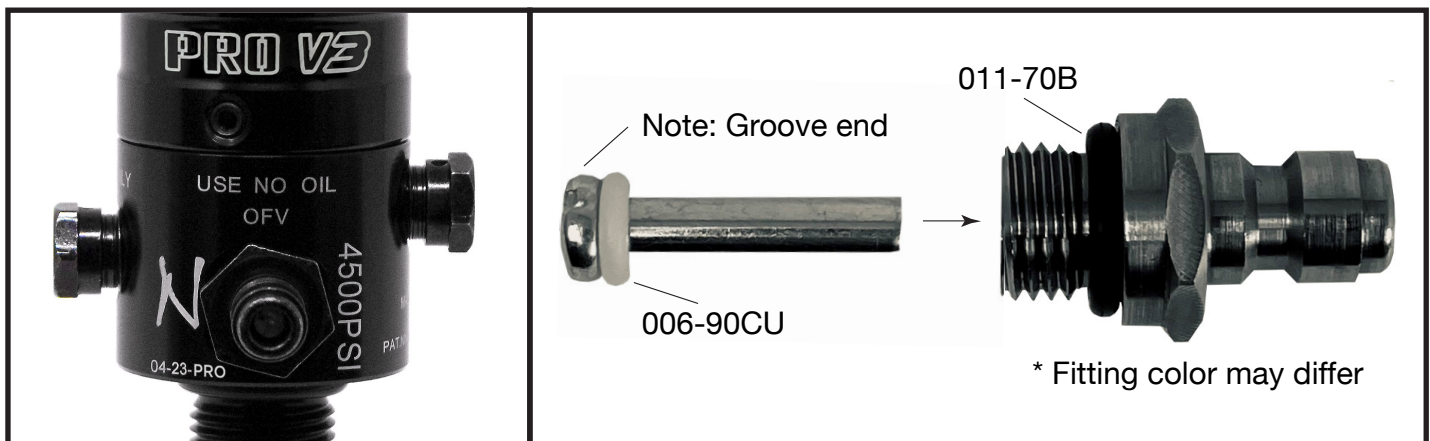

The regulator body will be marked "OFV" as shown in image.

BURST DISK REPLACEMENT

ASTM compliant unified burst disks are used on paintball regulators and CO2 valves for both the D.O.T. (Department of Transportation) required bottle protection and downstream over-pressure protection.

Four (4) most common burst disks:

- 1800 PSI. Used for downstream over-pressure safety on regulators.
- 3000 PSI. Used for the D.O.T. required safety on CO2 storage bottles.
- 5000 PSI. Used for the D.O.T. required safety on 3000psi N2/HPA storage bottles.
- 7500 PSI. Used for the D.O.T. required safety on 4500psi rated N2/HPA storage bottles.

⚠ WARNING: SERIOUS PERSONAL INJURY OR DEATH FROM IMPROPER DISK REPLACEMENT. IT IS ABSOLUTELY ESSENTIAL THAT YOU REPLACE FAILED UNITS WITH EXACT REPLACEMENTS!!

ASTM UNIFIED BURST DISKS HAVE THE PRESSURE IDENTIFICATION MARKED ON THE HEAD OF THE DISK. SOME DISKS MAY HAVE THE PRESSURE IDENTIFIER ON THE SIDE OF THE DISK.

IF YOU ARE UNSURE DO NOT GUESS! SEE A QUALIFIED AIRSMITH OR CALL NINJA PAINTBALL: (815) 477-0007.

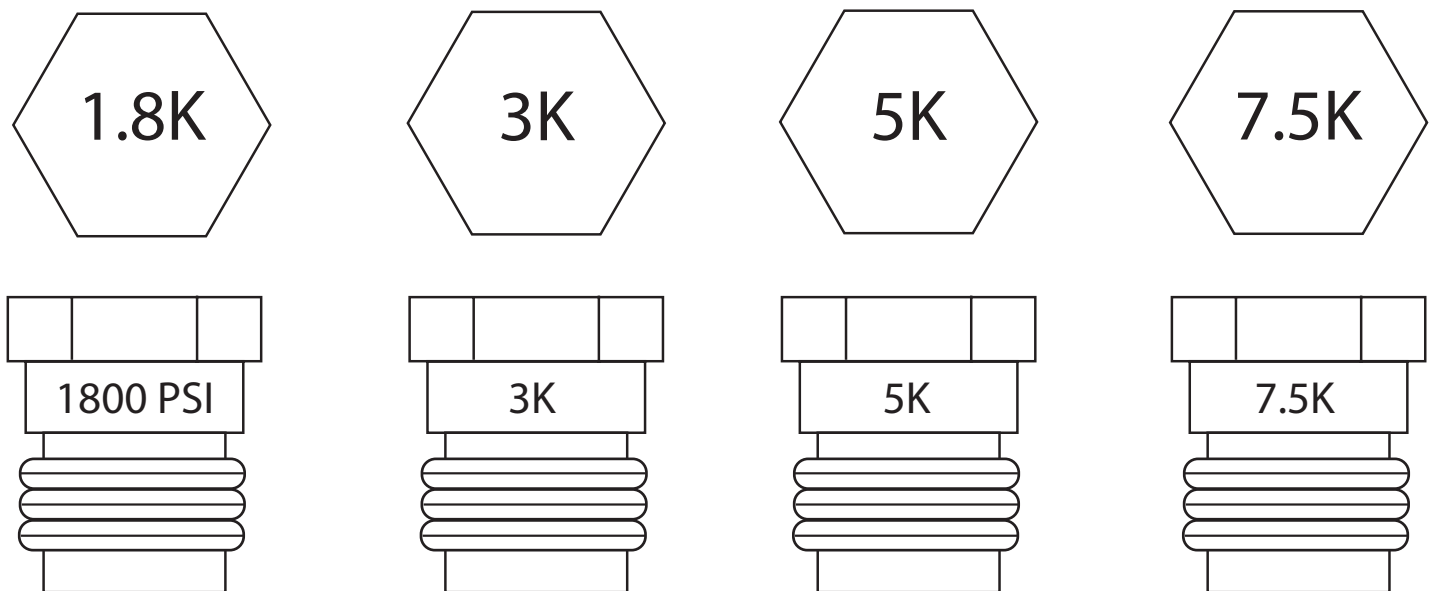

TO REPLACE A UNIFIED BURST DISK ASSEMBLY

1. Unscrew (turn counterclockwise) the failed unit and discard it.
(They are not serviceable)

2. Visually inspect the female port for damage or debris and clean out if necessary. If the port is damaged, do not replace the disk. Consult an air smith or call NINJA PAINTBALL for assistance: (815) 477-0007. We recommend the female port be checked with a 3/8-24 UNF-2B go/no go gauge available at www.msdirect.com.

3. Screw in the new NINJA UNIFIED BURST DISC and torque to a minimum 55 inch-pounds and a maximum 95 inch-pounds. **UNIFIED BURST DISK MUST BE ASSEMBLED WITH AN INCH POUND TORQUE WRENCH!**

4. If Burst Disk assembly does not seal at 95 inch-pounds, the valve should be inspected by an air smith or call NINJA PAINTBALL for assistance: (815) 477-0007.

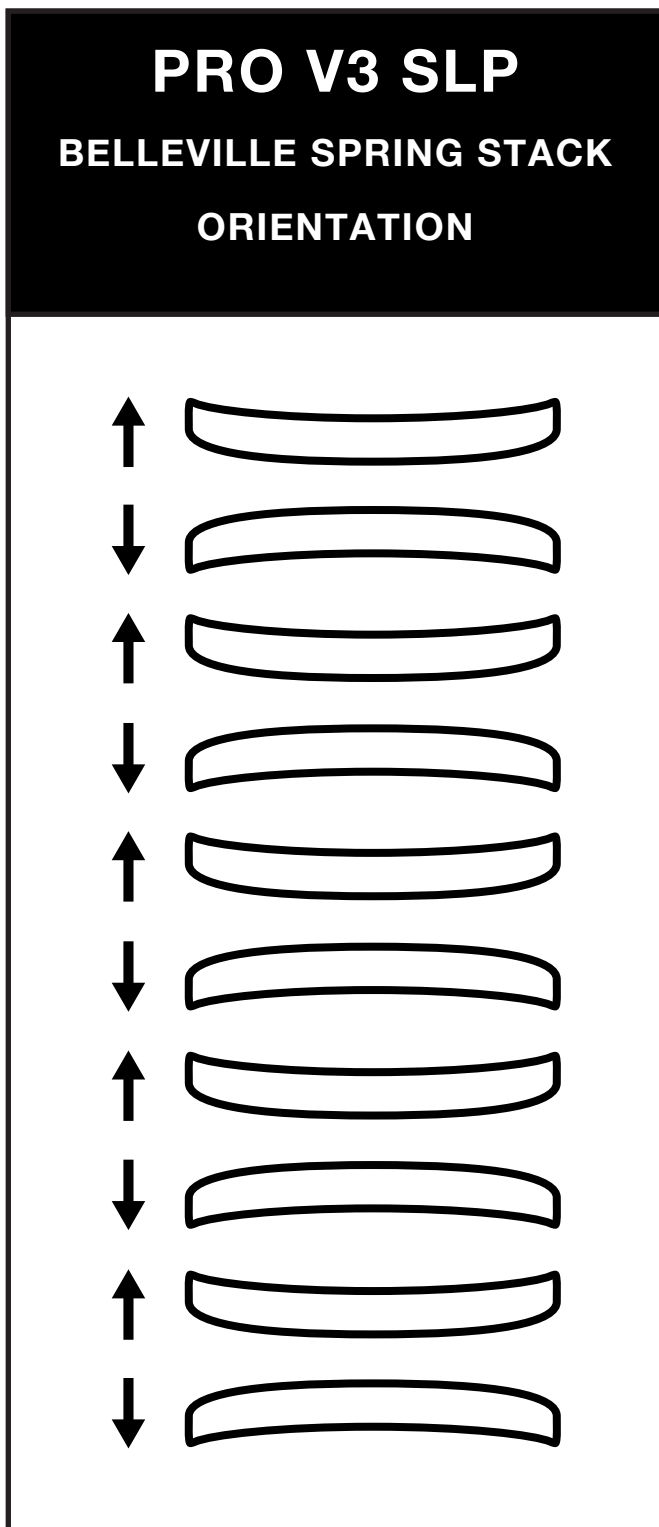

PRO V3 SLP PARTS KIT INCLUDED WITH REGULATOR

2. Bonnet Set Screws (8-32 x 3/16")
10. 008 Lower Piston O-ring (008-90U)
5. 012 Upper Piston O-ring (012-90U)
22. Bonnet Allen Key
9. Nylon Ball

NINJA PRO V3 SLP
REGULATOR PARTS DIAGRAM

1. Tank O-Ring (015-90u X 2)
 2. Bonnet Set Screws X3
Bonnet Sleeve Set Screws X3*
(8-32 x 3/16")
 3. Bonnet
 4. Bonnet Pin Seat (008-90CU)
 5. 012 Upper Piston O-Ring
(012-90u)*
 6. Pin
 7. Pin Spring
 9. Nylon Ball*
 10. 008 Lower Piston O-Ring
(008-90u)*
 11. D.O.T. Required (7.5K)
7500 PSI Bottle Burst Disk
 12. OFV (O-Ring Fill Valve
Body)
 13. Mini Gauge
 14. Low Pressure (1.8K)
1800 PSI Bottle Burst Disk
 15. OFV Strut
 16. Regulator Belleville Spring
Pack
 17. Piston
 18. Regulator Body
 19. Bonnet Sleeve
 20. OFV Strut O-ring
(006-90CU)
 21. ASTM Vent Groove
 22. Bonnet Set Screw Allen Key*
 23. Bonnet O-Ring (020-70B)
 24. Thick Bottle O-Ring
(112-70B)
- * Included in PRO V3 SLP
Parts Kit

